

- ^{ぶんどき}分度器の中心を点アに合わせて次の角度をかきましょう。

1 85°

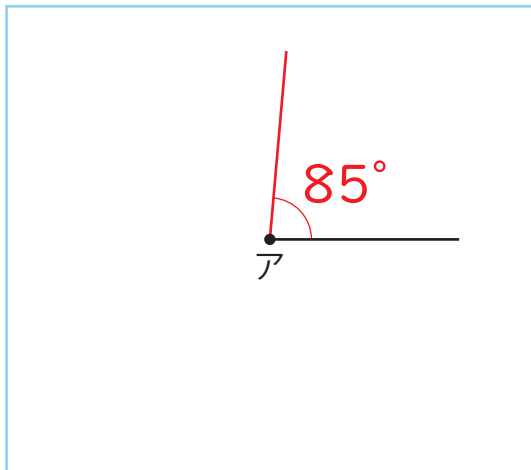

2 275°

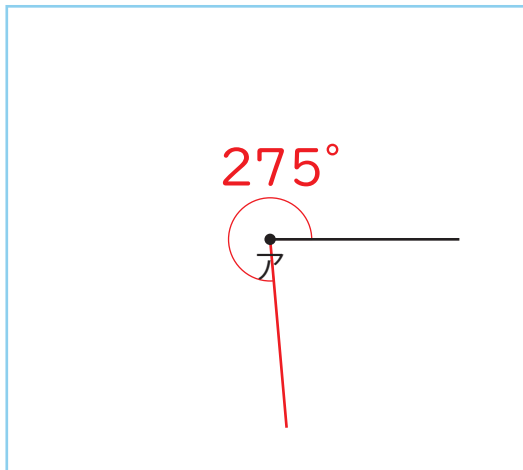

3 205°

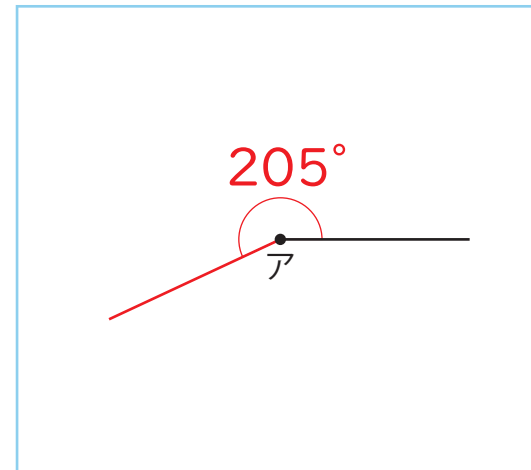

4 155°

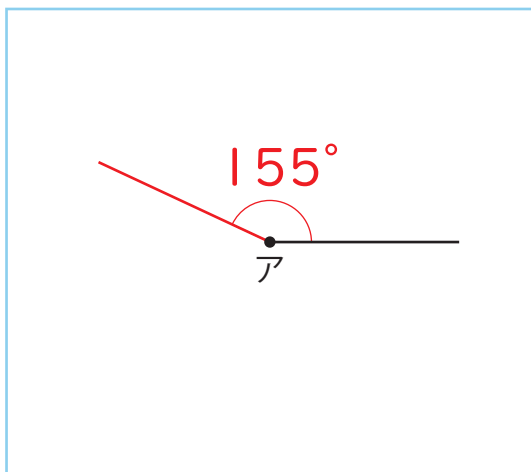

5 280°

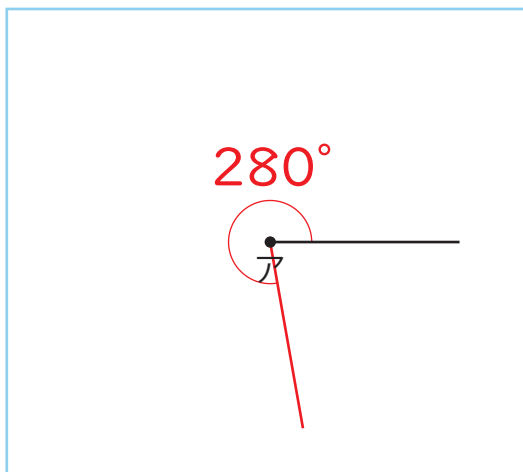

6 335°

